

Diritti riservati All rights reserved

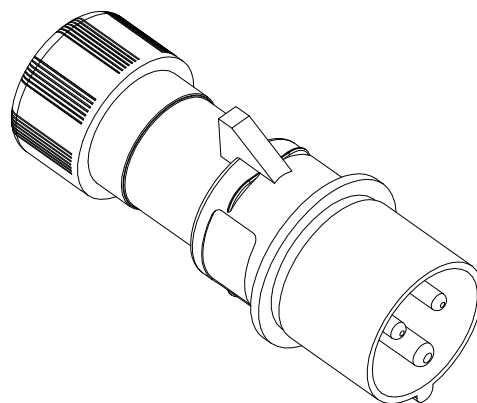
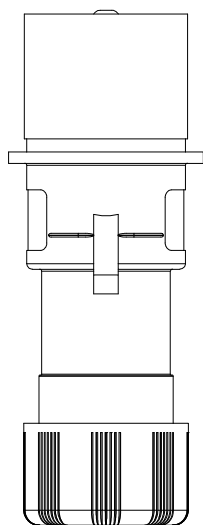
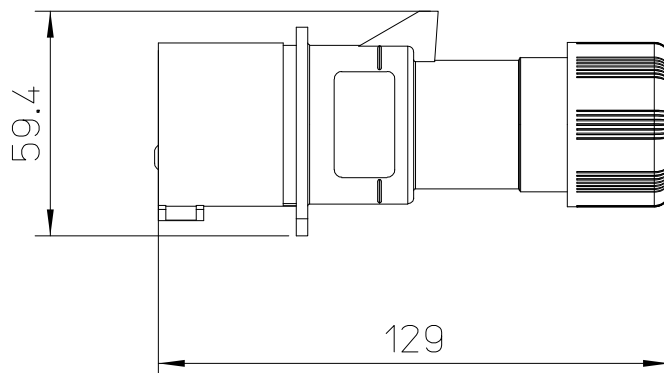
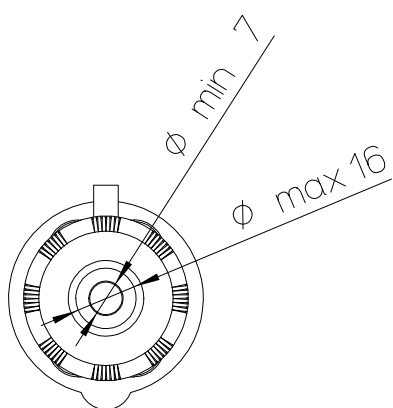

dimensions in mm
Date 19/05/2017
Sign. C. Mainini

**PE 1683 SV**  
**hoods, plugs, 2 poles + PE, 16A**

Scale  
1:2

